



VINYL AVENUE BANNER | 36"x18" Template

Double Face • 18 Oz. Vinyl • Finished with standard 3" Sleeves and Grommets at top and bottom

-  Magenta dotted line represents stitch line.
-  Blue line represents artboard or finished size.

1. Open this form in Illustrator and copy and paste the template on the right into your Illustrator or Photoshop file. The template is scaled to 10% of the actual finished size.
2. Make sure your artwork complies with our Art Guidelines listed at the bottom of this form.
3. Email order information, **PO #, Quantity, PMS Colors, and any special instructions**, along with your completed artwork to:
orders@flagsource.com

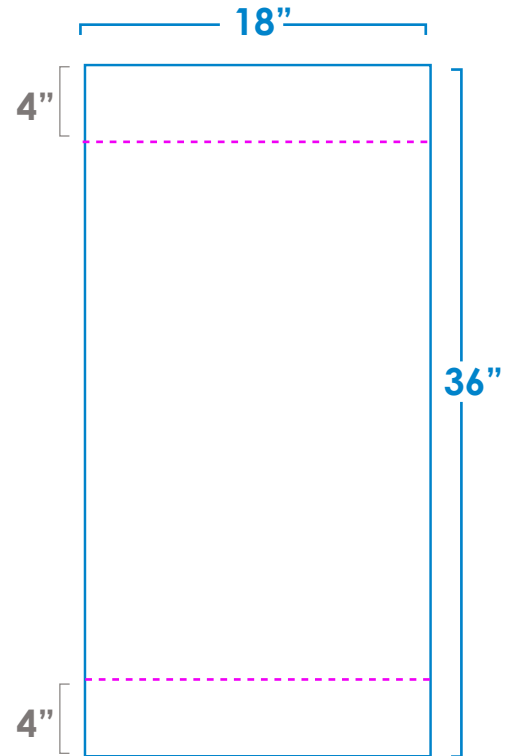

ART GUIDELINES

- Template is set to 10% scale.
- Do not change the shape of the template.
- Magenta dotted line shows where sleeve is sewn. It is recommended to keep important text between these guides. There is no sewing along the left and right sides of vinyl avenue banners.
- Allow background to bleed to edges.
- Convert all text to outlines.
- Outline all strokes.
- Use **Pantone Solid Coated** colors only. We can only guarantee color match to Pantone C colors. All other colors should be RGB and will be printed per file. Exact color on any per file colors cannot be guaranteed.
- Save and send all files as one of the following types.

Vector:	Raster: (Minimum 150 dpi at actual finished size)
.pdf	.tif
.ai	.jpg
.eps	.psd